

LIFA^{air}®

LAX200 Smart Air Purifier

User Manual

IMPORTANT!

Please read the user manual before using the product, and do keep securely for future reference.

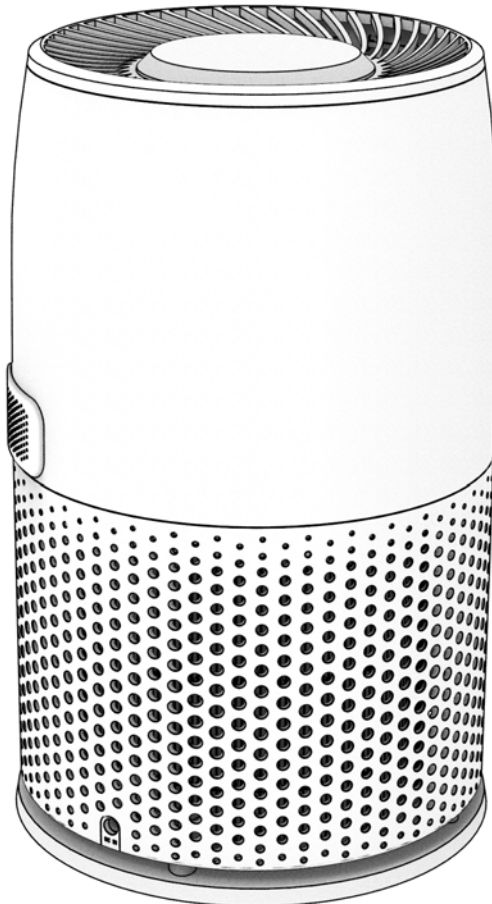

WARNING:

Before first time use, you must take out the HEPA filter and remove the protective plastic bag.

Contents

1. Important Safety Information	3
2. Package Contents	4
3. Functions	4
4. Technology	5
5. Filter Removal and Installation	6
6. Using the Air Purifier	7
7. Touchscreen and Functions	8
8. AUTO mode	9
9. Filter Replacement	10
10. Filter Care	10
11. Cleaning the Air Quality Sensor	11
12. Specifications	12
13. Troubleshooting	13



Lifa Air Plc
Eteläranta 14, 6th floor
00130 Helsinki, Finland

www.lifa-air.com

Customer service: care@lifa-air.com

1. Important Safety Information

- Only use attachments/accessories provided by the manufacturer.
- Keep the machine away from children to avoid accidents.
- Do not block any ventilation openings. Install the machine in accordance with the manufacturer's instructions.
- Make sure the machine stands in the upright position, never operate the machine when in other orientations.
- Unplug the machine when it is not being used for a long period of time. Do not use this machine in rooms with large temperature differences to avoid water condensation inside.
- Protect the power cord from being walked on or pinched. Please switch off and unplug the machine before moving it or cleaning and/or replacing the filters.
- Do not use this machine in high temperature and/or humidity environments, such as bathrooms. Never open the power adapter to avoid electric shock and impact on warranty.
- For user safety and product protection, do not sit or lean on the machine. Do not put objects into the movable portion, the air inlet and/or outlet. Do not place the product directly under air conditioning units to prevent condensed water droplets.
- With the exception of professional maintenance personnel, please do not attempt to repair the product.
- To prevent electric shocks, be sure to follow the requirements of the method and manner of this manual for cleaning and maintaining the product. Please do not try to maintain the product in any other way. Please ensure that the machine is used only with the power supply unit provided with the appliance.

Safety marking label of main unit is on the bottom plate of the product.



Correct disposal of this product. This marking indicates that this product should not be disposed with other household wastes throughout the EU. To prevent possible harm to the environment or human health from uncontrolled waste disposal, recycle it responsibly to promote the sustainable reuse of material resources. To return your used device, please use the return and collection systems or contact the retailer where the product was purchased. They can take this product for environmental safe recycling.

Power warning:

- Place the product near the power outlet.
- Before use, make sure that the operating voltage is the same as your local power supply. Correct operating voltage can be found on the product plate. For safety purpose, unplug the product during lightning storms or when unused for extended periods of time.
- Under normal conditions, the power supply may get hot. Please keep good ventilation in the area and exercise caution.

Safety warning labels on the housing or bottom of the product or power adaptor:



This symbol is to warn the user not to disassemble the enclosure of the product and there is no user-replaceable part inside. Take the product to an authorized service center for repair.



This symbol indicates that the product is for indoor use only.



This symbol signifies that the product have been assessed to meet high safety, health, and environmental protection requirements in the European Economic Area (EEA).

RoHS

This symbol indicates that the product is compliant with the regulation that restricts the use of specific hazardous materials found in electrical and electronic products.

2. Package Contents

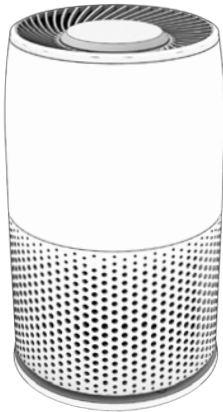

1 x
Air purifier
main unit



1 x
HEPA filter



1 x
Power cable



1 x
Power adapter

3. Functions

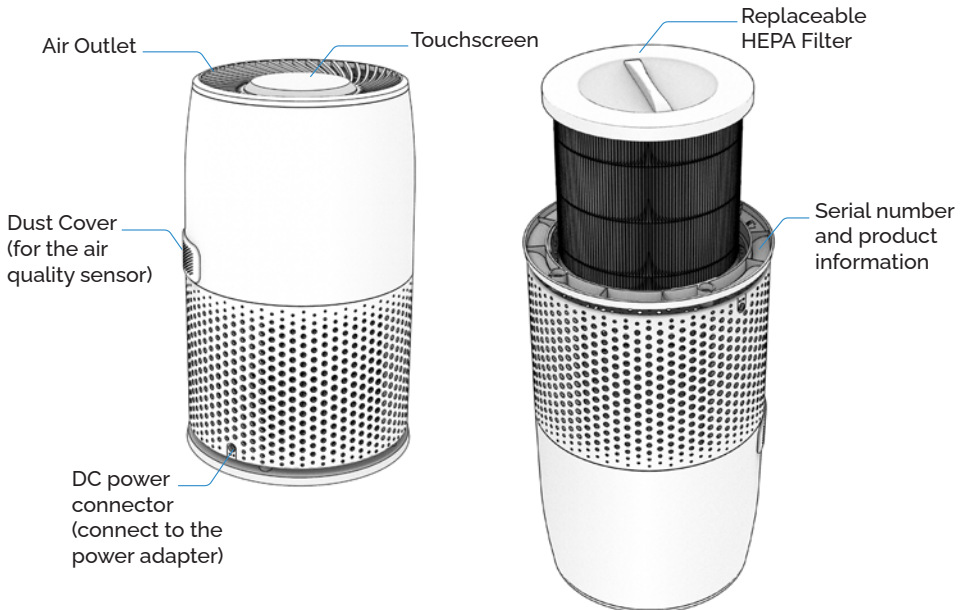

4. Technology



A Touchscreen
You can control all the functions of your air purifier through the touchscreen.

B Fan
Powerful yet quiet fan capable of delivering 170 m³/h of filtered fresh air.

C All-In-One HEPA H13 Filter
6G Filter combines industry standard high efficiency particle filter HEPA H13 with activated carbon material. The inner filter surface is coated with an antibacterial titanium dioxide coating.

D Ioniser
Anion generator creates negative ions that attach to and destroy harmful airborne particulates.

Ioniser is OFF by default, please turn it ON from the touchscreen.

E Air quality sensor
Built-in air quality sensor monitors the surrounding air quality and adjusts the purifier automatically.

F UV Light
UV light works together with filter materials to remove harmful contaminants from the air.

The UV light is OFF by default, please turn it ON from the touchscreen.

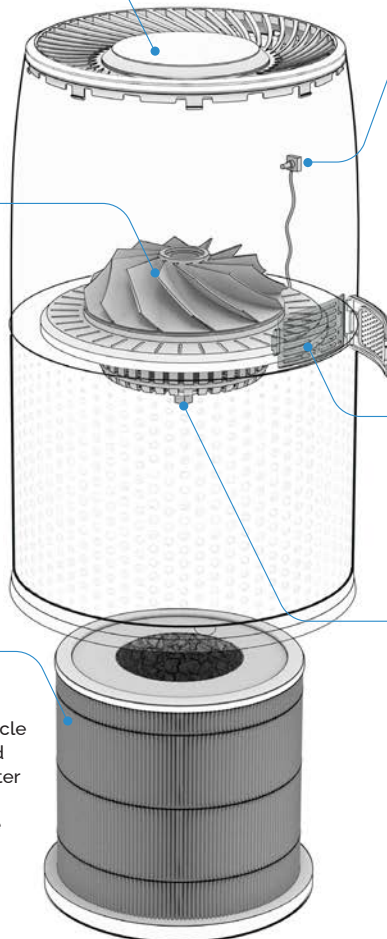

5. Filter removal and installation

ATTENTION! Before using the device for the first time, you must remove the filter from the device and remove the protective plastic bag around it. Please follow the steps below to do this.



1. Turn the air purifier upside down. To protect the touch screen from damage, place the device on top of a soft fabric or other suitable material.

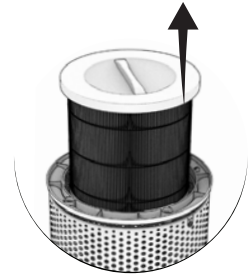
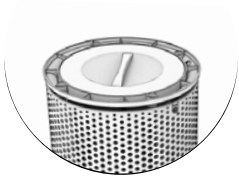

2. Turn the handle counterclockwise to unlock the filter and lift the filter out of the device.

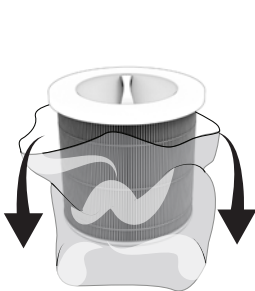

3. Make sure to remove the protective plastic bag around the HEPA filter

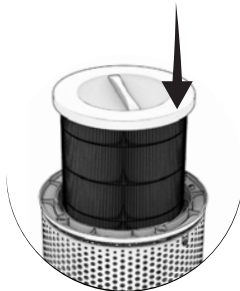

4. Push the HEPA filter back into the device and turn the handle clockwise to lock the filter in place.

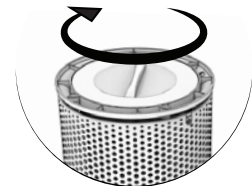

You can now start using your air purifier!

6. Using the air purifier

To optimize the performance of the product, please place the air purifier at least 15 cm away from nearby walls and at least 120 cm from the ceiling.

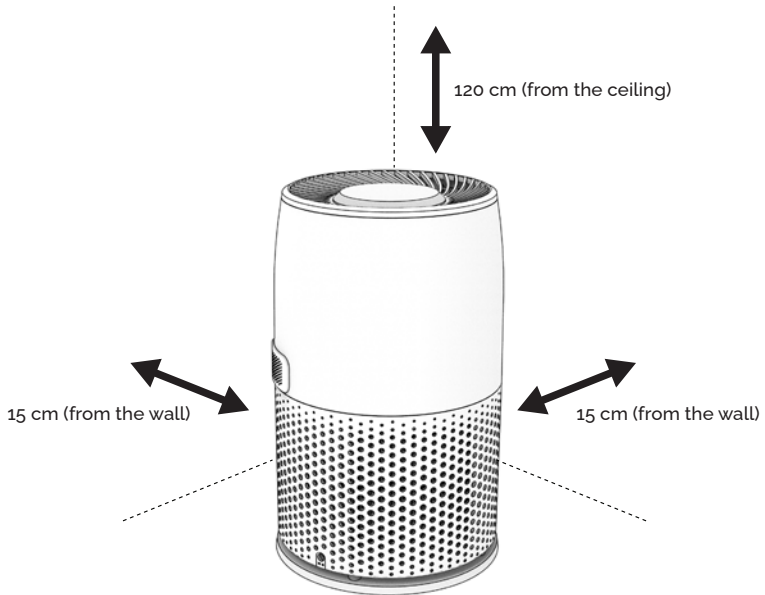

Remove all the protective plastic wrapping from the power components. Take out the power cord and connect to the power adapter. Connect the adapter to the main unit & plug in the power. The air purifier will beep and you can now start using its functions

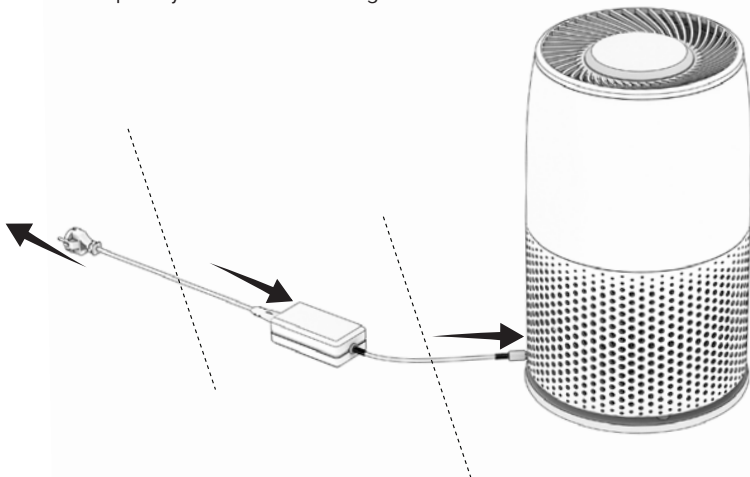

7. Touchscreen and Functions

1 **TIMER ON**
Use this function to set the time between 1-12 hours until you want the machine to turn ON.

2 **TIMER OFF**
Use this function to set the time between 1-12 hours until you want the machine to turn OFF.

3 **CHILD LOCK**
Use this mode to lock all the functions, thus preventing accidental changes. Press and hold for 3 seconds to lock/unlock.

4 **UV LIGHT**
Turn on the UV light to enhance the air purification efficiency of the purifier.
NOTE! The UV light is OFF by default.

5 **SPEED**
Manually adjust the fan speed between 4 different levels. Setting to AUTO mode will allow the machine to automatically adjust the fan speed according to the air pollution level detected.

6 **FILTER REPLACE**
This icon will start flashing to alert you the filter is reaching the end of its lifetime. Please change the filter.

7 **IONISER**
Turn the anion generator to enhance the air purification efficiency of the purifier.
NOTE! Ioniser is OFF by default.

8 **SLEEP**
Use this function to enjoy a quiet and a comfortable sleep. In this mode, the display lights will turn off and the purifier will be running at a low fan speed.

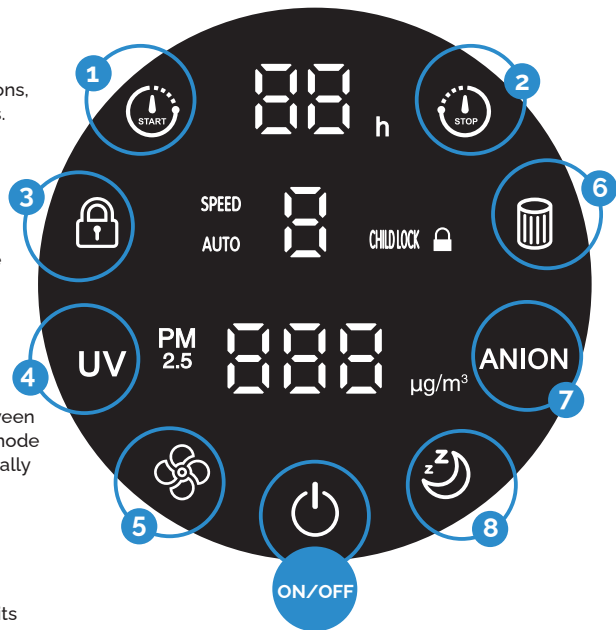

Use the power button to switch the purifier on/off.

8. AUTO mode

When you turn on the air purifier , the device will go into "AUTO mode" by default. In AUTO mode the air purifier is actively measuring the surrounding air quality and adjusting the fan speed accordingly. The LED ring will indicate the level of air pollution by displaying different colours.

The AUTO mode can be turned off by manually adjusting the fan speed  5.

The touchscreen will display the **PM_{2.5}** reading indicating the quality of the surrounding air. The reading starts from 10 $\mu\text{g}/\text{m}^3$ which equals clean air.

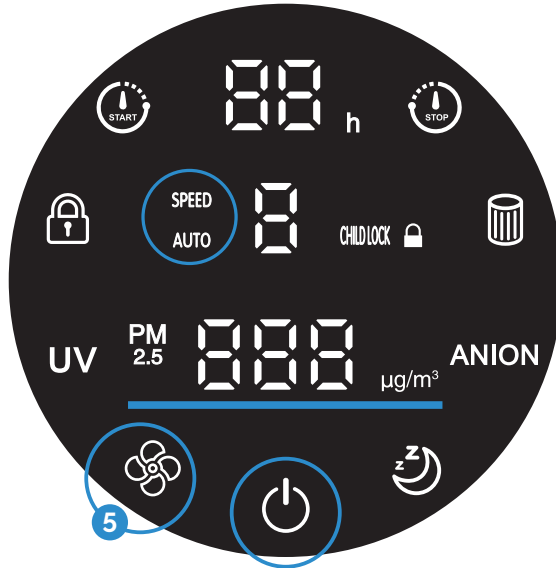

Colour codes for air pollution levels:

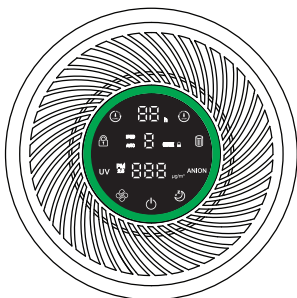

GREEN = Clean Air

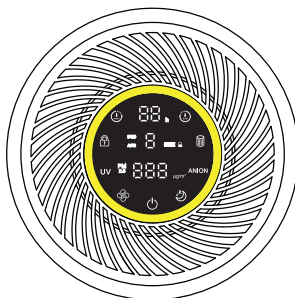

Yellow = Small To Medium Amounts Of Air Pollution

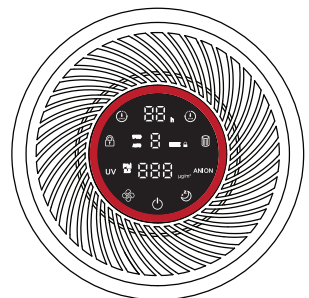

Red = High Amounts Of Air Pollution

9. Filter replacement

The FILTER REPLACE button **6** will start flashing once the operating time reaches the end of the filter's lifetime. It is then highly recommended to replace the 6G filter to keep running the air purifier at the maximum efficiency.

After installing a new filter, press and hold the FILTER REPLACE button **6** for 3 seconds to reset the built-in timer.

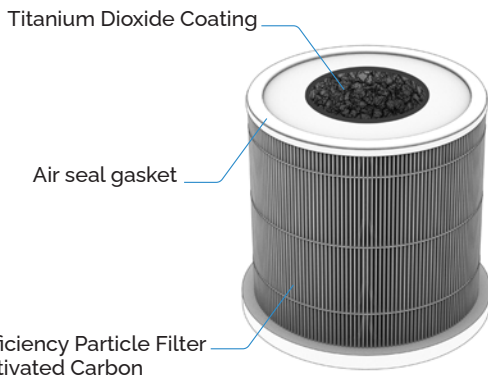

10. Filter care

Never wash the filter or try to wipe it clean with wet towel. You can use a vacuum cleaner or a dry brush to clean the outside surface of the filter. Do not touch the surface of the filter as it may contain harmful contaminants/particulates.

WARNING!

Do not to damage nor dent the surface of the filter.
Do not wash the filter with water. Keep away from heat and wet.
Do not touch the surface of the filter.

NOTE!

The standard time for filter replacement is 3000 hours of usage. The filter's lifetime will depend on the usage environment. In high pollution environments the usage time is less than in normal conditions.

WARNING!

In order to absorb and purify harmful gases, the filter core contains activated carbon material. It is highly recommended to wear a face mask during filter cleaning and/or replacement.

11. Cleaning the air quality sensor

When the lens of the sensor is stained or contaminated by moisture, particulates or smoke, the sensitivity of the sensor drops. Please follow the cleaning procedure below:



1. To remove the dust cover, press firmly with your fingers from the left side of the cover to release the locking mechanism. Continue to push from the left side and pull the cover off.

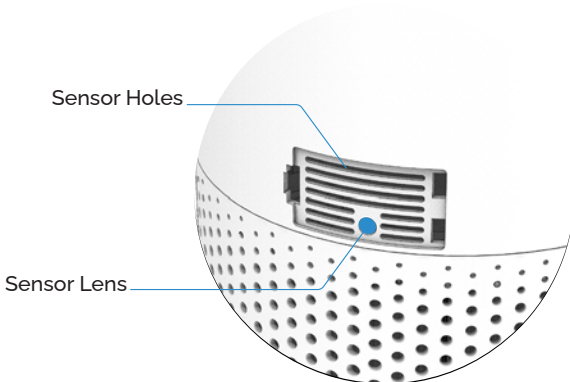

ATTENTION! For optimal function, clean the sensor monthly.

2. You can either use a vacuum cleaner or a hair dryer to remove the dusts on the sensor holes. Use a damp cloth or a cotton bud to clean the sensor lens and dry it out afterwards.

12. Specifications

Product Name:	LAX200 Smart Air Purifier
Model No.:	LAX200
Input Voltage (adapter):	220-240 V~ 50/60 Hz
Output Voltage (adapter):	24V DC
Rated Power Rate:	20W
Effective area:	25 m ²
CADR:	170 m ³ /h
Main product material:	ABS
Product size:	Diameter 218 mm, Height 350 mm
Product weight:	3 kg
Operating noise (4 fan speeds):	Normal mode: 23 dB(A) — Turbo mode: 62 dB(A)
Operating ambient temperature:	5-45 °C

LIFAair®

Lifa Air Plc
Eteläranta 14, 6th floor
00130 Helsinki, Finland

www.lifa-air.com

Customer service: care@lifa-air.com

13. Troubleshooting

Symptoms	Check	Fix
No exhaust	Is the filter removed from the plastic bag?	Remove the plastic bad before using.
	Is the filter installed correctly?	Please confirm whether the filter is installed correctly.
No change of air volume	Is the filter blocked?	Please clean the filter.
The air volume decreases compared to the newly purchased unit.	Air flow volume might temporarily drop due to special circumstances.	It is required to replace the filter in the case of no improvement.
	Please confirm the current "running mode" is not set to "auto mode" or "sleep mode"?	Please confirm whether the "running mode" can be changed by the "mode switch button".
Not react to "dust" and "odor" although setting as the auto mode.	Is the sensor blocked by the wall or any barrier?	In the case of being blocked, please remove the barrier. In the case of no barrier, please clean the sensor: at the back of the machine.
Peculiar smell on air outlet	Check if the filter is new.	Due to high performance activated carbon as the raw material, it may be sweet at the beginning of use. Generally the initial odor may decrease after using for about a week.
	Is it used in the space with odor causing discharge or a large number of peculiar smell discharged from cooking?	The filter has the nature of adsorbing the odor, so it will accumulate the odor temporarily. After a short period of operation, the smell will gradually weaken.
	Filters containing activated carbon sometimes emit a slight strong aroma.	After a short period of operation, the smell will gradually weaken.
	Is it moved from other room?	Sometimes it is the odor from the previously used location. The odor will decrease gradually after short-time running.
"Clean filter" alert flashes	Has the filter replacement reminder been reset?	Please reset the "Filter Replace" button by holding it for 3 seconds.
Discharge of black powders from the filler can be seen.	This is the raw activated carbon content of the filter.	Please sweep the filter surface and collect the loosen activated carbon powders during the filter replacement.
An odor fails to dissipate.	The deodorization ability of the filter can be automatically restored at a corresponding degree. It may not be restored depending on environment of use.	Remove the filter and air-dry for at least 12 hours in a well-ventilated place.
	Odor sensed continuously at certain degree.	Look for factors that continuously be a source of odor (like pets, paint etc.) The machine cannot totally eliminate it, Proper ventilation of the space might be needed.

LIFAair®

Lifa Air Plc
Eteläranta 14, 6th floor
00130 Helsinki, Finland

www.lifa-air.com

Customer service: care@lifa-air.com



LOVEAIR

Instrukcja pobrana ze strony loveair.pl